

HITACHI

Inspire the Next

Single Phase IT & Infra UPS Systems

Range: 6 kVA to 10 kVA (1:1)

HS11 Series IT & Infra UPS



Exceptional safeguard against Power Disruption

About HS11 Series IT & Infra UPS

HS11 Series UPS is a true on-line UPS with microprocessor controller that delivers continuous, high-quality AC power to connected equipment with no interruption when transferring to battery. It provides protection from blackouts, brownouts, sags, surges or noise interference and provides reliable and stable power.

This UPS is a full feature transformer free UPS designed to offer compact, efficient and reliable solutions to modern electronic gadgets. It features true double conversion on line back up power solution for small data centres, data networks, voice networks and process automation equipments.

Hs11 Series UPS provides customers with a reliable source of uninterruptible power even in harsh power

environment, including very wide input voltage / frequency window, better output voltage regulation, frequency regulation, internal bypass, and input power factor correction and low THDi.

It has built-in RS-232 and bundled monitoring software. This online UPS offers enhanced performance for power monitoring.



Advantages

- Easy to install and operate
- Compact footprint
- Robust and reliable connectivity
- LCD interface
- UPS can be configured with or without battery
- UPS can be configured to ECO mode
- Designed to operate in challenging electrical environment
- Low EMI emission compliant for commercial installation
- Large input voltage window
- Available in variable DC link in 6-10 kVA UPS for extend battery backup

Features

- High frequency and double conversion on line technology
- Advanced PFC & IGBT technology
- Lighting and surge protection
- Fan speed auto control when loads varies
- Short circuit and overload protection
- Smart RS 232 communication with monitoring software
- EMI/RFI noise filter
- Cold start facility
- MTBF 300000 hrs
- Hot standby configuration
- High input power factor

Technology

Advanced PFC & IGBT technology

The Solution For

- Small range server and corporate network
- Routers, switches and hubs
- Personal workstation
- Security system
- Service sector, Wi-Fi application
- Infrastructure, small office network
- Health sector, medical equipments
- Banks and ATMs
- Sensitive electronics equipments
- Process automation equipments

Optional Features

- Extended battery pack
- SNMP card
- Internal isolation transformer
- Remote monitoring service through SNMP
- Modbus card
- AS-400
- 6A extra charger card

Configuration

- Standalone UPS
- Standalone with inbuilt isolation transformer
- HSB mode with individual battery bank
- In-built battery

Certification



Input / Output Connection

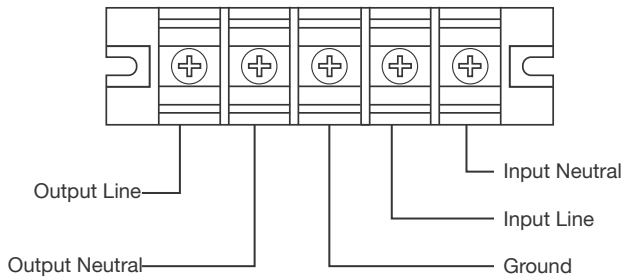

MODbus

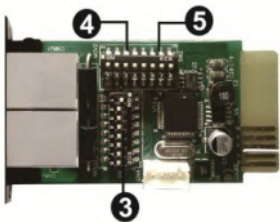
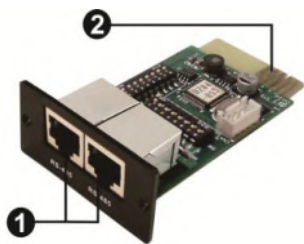

- 1 RS-485 port
- 2 Golden finger
- 3 Address switch
- 4 Communication setting

Communication Connection

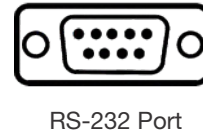

SNMP



AS-400 Remote shutdown

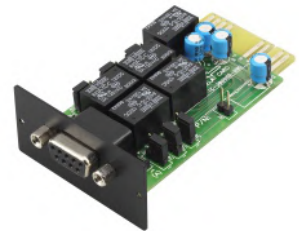

Control Panel

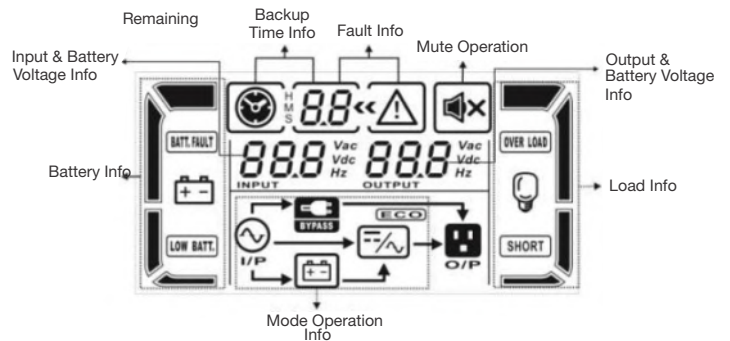

Connections

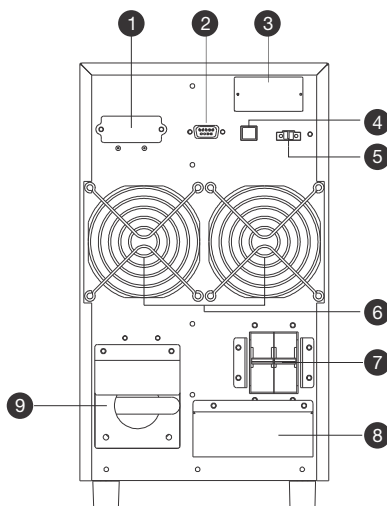

HS11- 6/10 kVA

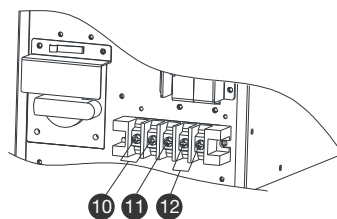

- 1 External battery connector
- 2 RS-232 communication port
- 3 Intelligent slot
- 4 USB communication
- 5 Emergency power off function connector (EPO connector)
- 6 Cooling fan
- 7 Input circuit breaker
- 8 Input/Output terminal
- 9 Maintenance bypass switch
- 10 Output terminal
- 11 Grounding terminal
- 12 Utility input terminal

Technical Specifications

Model		HS11S-6 / HS11H-6	HS11S-10 / HS11H-10
Phase		Single Phase with ground	
Capacity		6000 VA / 4800 W	10000 VA / 8000 W
Input			
Nominal Voltage		220 / 230 / 240 VAC	
Input Voltage Range		176 - 280 VAC (Based on Load at 100%)	
Frequency Range		46 Hz ~ 54 Hz @ 50 Hz System 56 Hz ~ 64 Hz @ 60 Hz System	
Power Factor		≥ 0.99 @ Nominal voltage (100% Load)	
Output			
Output Voltage		220 / 230 / 240 VAC	
Voltage Regulation		± 1%	
Frequency Range (Synchronized Range)		47~ 53 Hz or 57 ~ 63 Hz	
Frequency Range (Batt. Mode)		50 Hz ± 0.25 Hz or 60 Hz ± 0.3 Hz	
Overload		100% - 110% 10 min. 110% - 130% 1 min. >130% 1 sec	
Current Crest Ratio		3:1 Max	
Harmonic Distortion		≤ 3 % THD (linear load) ≤ 6 % THD (non-linear load)	
Transfer Time	AC Mode to Battery Model	0 ms.	
	Inverter to Bypass	0 ms.	
Waveform (Batt. Mode)		Pure sinewave	
Efficiency			
AC Mode (Overall)		88%	88%
Battery Mode (Inverter)		83%	87%
Battery			
Standard Model	Battery Type	12 V / 7 AH	
	Numbers	16	
	Typical Recharge Time	9 Hours recover to 90% capacity	
	Charging Current (max.)	1A ± 10%	
	Charging Voltage	218.4 VDC ± 1%	
Long-run Model*	Battery Type	Depending on the capacity of external batteries	
	Numbers	16 - 20	
	Charging Current (max.)	1A / 2A / 4A / 6A (adjustable)	
	Charging Voltage	218.4 - 272 VDC ±1%	
Physical			
Standard Model	Dimensions (WxDxH) (mm)	369 x 190 x 688	442 x 190 x 688
	Net Weight (kgs)	72	82
Long-run Model**	Dimensions (WxDxH) (mm)	369 x 190 x 318	442 x 190 x 318
	Net Weight (kgs)	21	23
Environment			
Operation Temp		0 - 40°C (Battery life cycle will be shorten when temperature is above 25°C)	
Operation Humidity		<95 and condensing	
Noise Level		Less than 55 dB @ 1 meter	Less than 58 dB @ 1 meter
Management			
Smart RS-232/USB		Supports windows 2000 / 2003 / XP / Vista / 2008 / 7 / 8, Linux, Unix and MAC	
Optional SNMP		Power management from SNMP manager and web browser	

* Derate to 80% of capacity in frequency converter mode and to 90% when the output voltage is adjusted to 208 VAC.

** If the UPS is installed or used in place where the altitude is above than 1000m, the output power must be derated one percent per 100m.

* Product specifications are subject to change without further notice.

Contact us

Hitachi Hi-Rel Power Electronics Private Limited

Registered Office:

B-52, Corporate House,
Near Judges Bungalow, Bodakdev,
Ahmedabad-380054, Gujarat, India.
Tel: +91-79-6604 6200,
Fax: +91-79-6604 6243

Manufacturing Works:

Survey # 3 & 4, Sanand GIDC II,
Industrial Estate, Nr. Bol Village,
Chharodi, Sanand-382110,
Gujarat, India.
Tel: +91-2717-678777,
Fax: +91-2717-678700

Gandhinagar Facility:

B - 14/1 & 171, GIDC Electronics Zone,
Sector - 25, Gandhinagar - 382 044,
Gujarat, India.
Tel: +91-79-6170 0500

 **Helpline:** (080) 6112 0800 (For Sales & Service)

 contact@hitachi-hirel.com

 www.hitachi-hirel.com

 [/company/hitachihirel](https://www.linkedin.com/company/hitachihirel)

 [/hitachihirelindia](https://www.youtube.com/hitachihirelindia)

 [/hitachihirel](https://www.facebook.com/hitachihirel)



e-gallery